

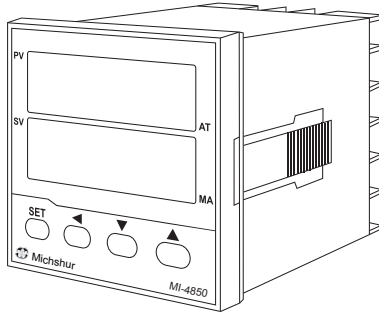

Michshur

MI-4850 Process Controller Installation and Operation Guide



Communication :

- Interface : Half duplex based on EIA RS-485
- Protocol : ModBus RTU mode
- Data format :
 - Start bit : 1
 - Data bit : 8
 - Parity : None
 - Stop bit : 2
- Baud Rate : 2400, 4800, 9600, 19200 bps
- Power supply : 90~265 Vac, 50/60 Hz.
- Power consumption : 4VA Max.
- Common mode rejection ratio : >80dB.
- Operating temperature : 0 to 50°C
- Humidity : 0 to 85% RH (Non-Condensing)
- Electromagnetic compatibility (EMC) : En 50081-2, En 50082-2
- Dimension : 48x48x55 mm (WxHxD).
- Hoisting material : ABS plastic. UL 94V0
- Weight : 100g

1.3. Ordering information

MI-4850							
Input	Code	Output	Code	Communication	Code	Protection	Code
T/C	T	Relay	R	None	N	None	0
RTD	D	SSR	P	RS-485	C	IP65	5
0mV to 60mV DC	L	2nd Alarm	A				
0 to 10V DC	V						
0 to 24mA DC	M						

2. Installation

2.1. Panel mounting

- Prepare the panel cutout with proper dimensions (45.5^{+0.5}_{-0.0} X 45.5^{+0.5}_{-0.0} mm)
- Insert the controller into the panel cutout from the front of the panel.
- Secure the controller by pushing the mounting bracket into the controller from the rear side.
- Tighten the screws of the mounting bracket slightly if the controller is not firmly secured

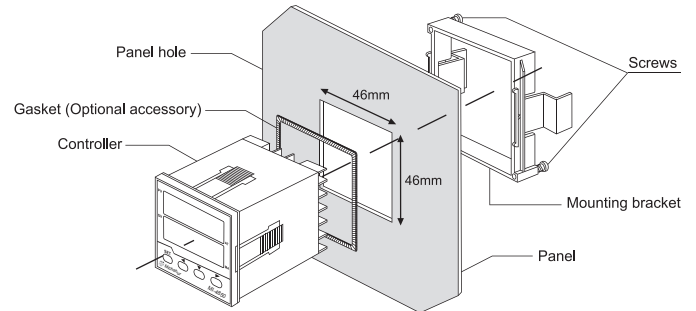

Figure 1. Panel mounting

2.2. Connections and wiring

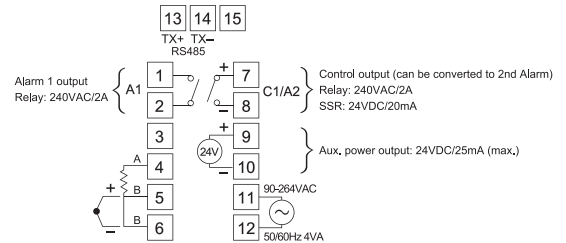

Figure 2. Terminal connections

Wiring precaution:

Inverter, mechanical contact relays, arc welders, and ignition transformers are all common sources of electrical noise in an industrial environment, so always keep signal wires away from those noise-generating devices.

3. Operation

3.1. Front panel description

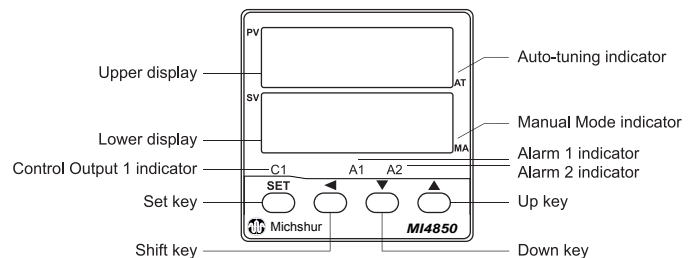

Figure 3. Front panel description

- PV (Upper display) : Display the process Value, parameter index code or error code
- SV (Lower display) : Display the set point value or the set value of parameter
- C1 : Control output 1 indicator
- A1 : Alarm 1 indicator
- A2 : Alarm 2 indicator
- AT : Auto-tuning indicator (The right-most decimal point of upper display)
- MA : Manual mode indicator (The right-most decimal point of lower display)

1. Introduction

1.1. Highlight Features

- Space saving, only 55mm panel depth required
- Higher sampling rate (100mS) results in better control performance
- Protect the load from thermal shock (unwanted rapid temperature rise) using the excellent ramp rate feature
- Protect the heating element from excess current during power-up using the soft start function
- Easy to read 0.4" / 10mm LED display showing SV/PV at a glance
- NEMA-4 IP65 front panel protection when used with panel gasket or IP63 without

1.2. Specification

- Input signal : User programmable. refer to table 1.
- Thermocouple (T/C) : industry standard thermocouple types, J, K, T, E, B, R, S, N, C (ITS-90).
- Pt100 : Excitation 180uA. 2 or 3 wire connection (ITS-90 $\alpha=0.00385$).
- Voltage : -60mVdc to 60mVdc or -10Vdc to 10Vdc.
- Current : 0mA to 24mA

Measuring range : User programmable. Maximum range refer to table 1.

Measuring accuracy : refer to Table 1. the accuracy is tested under the operating condition of 24°C±3°C.

Input signal	Maximum Range	Accuracy
Thermocouple J	-50 to 1000°C (-58 to 1832°F)	±1°C
Thermocouple K*	-50 to 1370°C (-58 to 2498°F)	±1°C
Thermocouple T	-270 to 400°C (-454 to 752°F)	±1°C
Thermocouple E	-50 to 700°C (-58 to 1832°F)	±1°C
Thermocouple B	0 to 1750°C (32 to 1832°F)	±2°C (Note1)
Thermocouple R	-50 to 1750°C (-58 to 1832°F)	±2°C
Thermocouple S	-50 to 1750°C (-58 to 1832°F)	±2°C
Thermocouple N	-50 to 1300°C (-58 to 1832°F)	±2°C
Thermocouple C	-50 to 1800°C (-58 to 1832°F)	±2°C
Pt100	-200 to 600°C (-58 to 1832°F)	±0.2°C
mA	0.000 to 24.000mAdc	±3μA
mV	-60.00mV to 60.00mV	±0.01mV
Voltage	-10.000 to 10.000Vdc	±1mV

*Factory Setting

Note 1 : Accuracy is not guaranteed between 0 and 400°C (0 and 752°F) for type B.

Table 1 Input Signal

Sampling rate : 100mS

Control Output :

- Relay output : 2A/240Vac (Resistive load)
- Pulsed Voltage output : DC 0/24V (Resistive load 250 ohms Min.)

Control Mode : PID with auto-tune, P with manual reset or On/Off with hysteresis available.

- Proportional Band : 0.0~300.0% (0.0 % = On/Off mode)
- Integral Time : 0.0~3000 sec.
- Derivative Time : 0.0~1000 sec.
- Cycle Time : 1~60 sec.
- Hysteresis : 0~9999

Ramp Function :

- Ramp rate : 0~9999 unit/minute or unit/second (0 = disable the ramp function)
- Alarm Output : 2A/240Vac (Resistive load)

Alarm Function : Energized / De-energized with 0~30000 Sec. / Min. delay

- No alarm
- Process high alarm
- Process low alarm
- Deviation high alarm
- Deviation low alarm
- Inside deviation band alarm
- Outside deviation band alarm

Alarm Mode :

- Normal mode
- Standby mode
- Latch mode
- Standby and Latch mode

Keypad description

- SET key : Use to menus navigation and set value registration
- Shift key : Shift the digit of numeral
- Down key : Decreases the parameter value or change the setting
- Up key : Increases the parameter value or change the setting
- SET + Shift key for 2 sec. : Enter set up mode
- SET + up key : Return to PV/SV display
- Shift + Down key on powering up : set all parameters to default setting

3.2.Powering up procedure

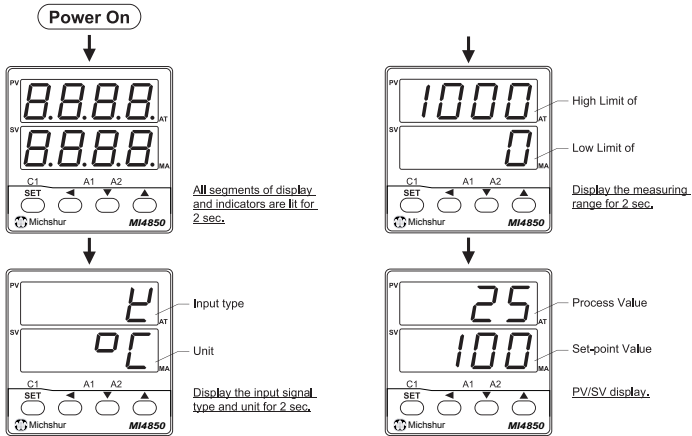

Figure 4. Powering up procedure

3.3.Configuration

3.3.1.Menu Flowchart

After powering up procedure, the controller stays in PV/SV display. The upper display shows the process value (measuring value) and the lower display shows the set point value (target value). All the configurable parameters are located in different levels and can be accessed by keypad operation as shown in figure 5.

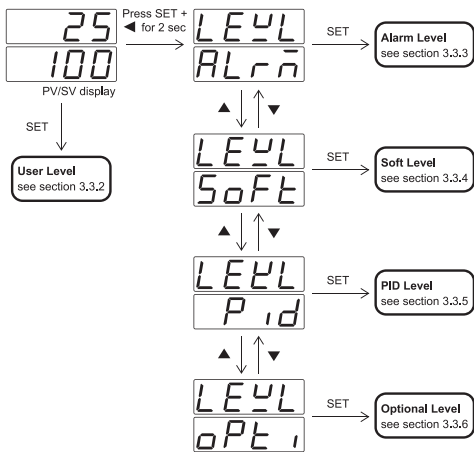

Figure 5. Menu flowchart

3.3.2.User Level

Display	Description	Range	Default	Unit
<i>PvOff</i>	Process value offset correction	-1000~1000 (<i>dP</i> =0000) -100.0~100.0 (<i>dP</i> =0000) -10.00~10.00 (<i>dP</i> =0000) -1.000~1.000 (<i>dP</i> =0000)	0	
<i>oUtl</i>	Control output percentage	0.0~100.0%	N/A	%
<i>rUn</i>	Control mode	<i>oFF</i> : Off <i>on</i> : On <i>At1</i> : AT1 <i>At2</i> : AT2 <i>Man</i> : Man	On	-

Process value offset correction

The value to be added to the PV to correct the sensor offset error.

Control output percentage

In Auto mode (*rUn* = *on*), it shows the percentage of power applied to the control output. In Manual mode (*rUn* = *Man*), the upper display will show the process value (PV) and "oUtl" alternately and the "MA" indicator is lit. The value of percentage can be changed manually.

Control mode

Select the control mode to be

- Off – Standby mode. Both control output and alarm are turned off.
- On – Auto mode (closed loop control). In this mode, the control output percentage is determined by PID algorithm or ON/OFF action.
- AT1 – Auto-tuning mode 1. In this mode, the controller will tune the PID parameters automatically at SV. The process will oscillate around the SV during AT1 process (Figure 6). Use AT2 mode if overshooting beyond the normal process is likely to cause damage.
- AT2 – Auto-tuning mode 2. In this mode, the controller will tune the PID parameters automatically at (SV-10%). The process will oscillate around (SV-10%) during AT2 process (Figure 6).
- Man – Manual mode (open loop control). In this mode, the control output can be set manually.

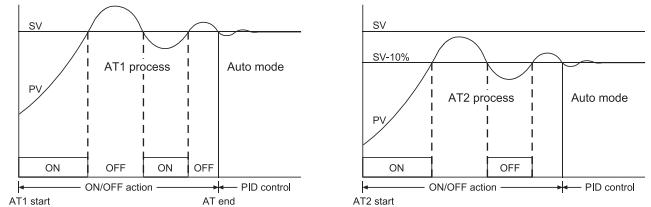

Figure 6. Auto-tuning Process

3.3.3.Alarm Level

Display	Description	Range	Default	Unit
<i>R1SP</i>	Alarm 1 set-point	-1999~9999 (<i>dP</i> =0000) -199.9~999.9 (<i>dP</i> =000.0) -19.99~99.99 (<i>dP</i> =00.00) -1.999~9.999 (<i>dP</i> =0.000)	10	unit
<i>R1HY</i>	Alarm 1 hysteresis	0~9999 (<i>dP</i> =0000) 0~999.9 (<i>dP</i> =000.0) 0~99.99 (<i>dP</i> =00.00) 0~9.999 (<i>dP</i> =0.000)	0	unit
<i>R1FU</i>	Alarm 1 function	<i>RoFF</i> : A.oFF <i>RHi</i> : A.Hi <i>RLo</i> : A.Lo <i>RdHi</i> : A.diH <i>RdLi</i> : A.diL <i>RbdH</i> : A.bdH <i>RbdL</i> : A.bdL <i>boFF</i> : b.oFF <i>bHi</i> : b.Hi <i>bLo</i> : b.Lo <i>bdHi</i> : b.diH <i>bdLi</i> : b.diL <i>bbdH</i> : b.bdH <i>bbdL</i> : b.bdL	A.diH	N/A
<i>R1m</i>	Alarm 1 mode	<i>nonE</i> : None <i>Stdy</i> : Stdy <i>LAtH</i> : LAtH <i>StLA</i> : StLA	None	N/A
<i>R1dt</i>	Alarm 1 delay time	oFF, 00.01~99.59	oFF	HH.MM/MM.SS
<i>R2SP</i>	Alarm 2 set-point*	Same as Alarm 1 set-point	10	Unit
<i>R2HY</i>	Alarm 2 set hysteresis*	Same as Alarm 1 set hysteresis	0	Unit
<i>R2FU</i>	Alarm 2 function	Same as Alarm 1 function	A.diL	N/A
<i>R2m</i>	Alarm 2 mode*	Same as Alarm 1 mode	None	N/A
<i>R2dt</i>	Alarm 2 delay time*	Same as Alarm 1 delay time	oFF	HH.MM/MM.SS

*All the alarm 2 parameters are only shown when the control output is set as 2nd alarm action.

Alarm 1 set-point, Alarm 2 set-point

The set point of alarm even

Alarm 1 hysteresis, Alarm 2 hysteresis

The hysteresis of alarm action

Alarm 1 function, Alarm 2 function

Select the alarm function

- A.oFF – Alarm action off.
- A.Hi – Process high alarm with Form A contact
- A.Lo – Process low alarm with Form A contact
- A.diH – Deviation high alarm with Form A contact
- A.diL – Deviation low alarm with Form A contact
- A.bdH – Deviation band high alarm with Form A contact
- A.bdL – Deviation band low alarm with Form A contact
- b.oFF – Alarm action off
- b.Hi – Process high alarm with Form B contact
- b.Lo – Process low alarm with Form B contact
- b.diH – Deviation high alarm with Form B contact
- b.diL – Deviation low alarm with Form B contact
- b.bdH – Deviation band high alarm with Form B contact
- b.bdL – Deviation band low alarm with Form B contact

Alarm indicator lite

Alarm indicator off

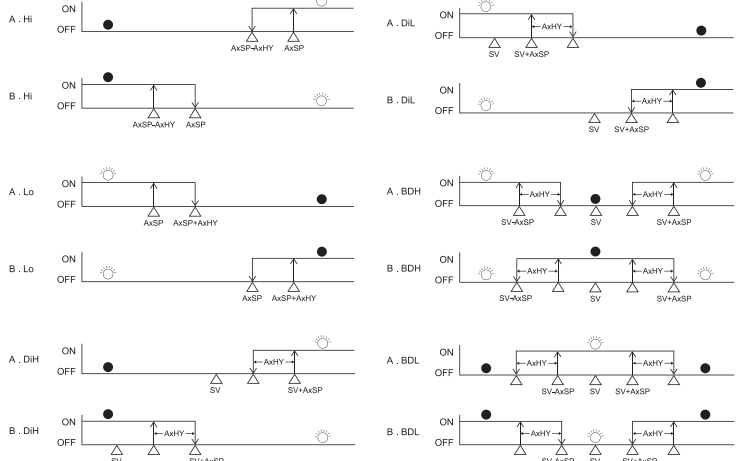

Figure 7. Alarm function

Alarm 1 mode, Alarm 2 mode

Select the alarm mode as

None – Disable the alarm mode

Stdy – Standby mode. When selected, prevents an alarm on power up. The alarm is active after alarm condition has been cleared and then alarm occurs again.

LATH – Latch mode. When selected, the alarm output and indicator latch as the alarm occurs. The alarm output and indicator will not change its state even if the alarm condition has been cleared unless the power is off.

StLA – Both standby and Latch mode are applied.

Alarm 1 delay time, Alarm 2 delay time

Alarm delay time is set to postpone the alarm action by the setting time.

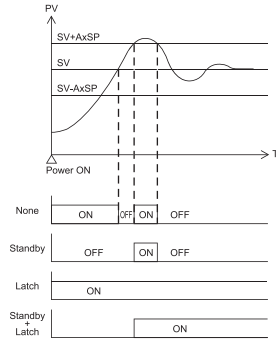

Figure 8. Alarm Mode

3.3.4. Soft Level

Display	Description	Range	Default	Unit
rARP	Ramp rate	oFF, 1~9999 (0.1~999.9)	oFF	
SoFt	Soft start time	oFF, 00.01~99.59	oFF	

Ramp rate

The controller can act as either a fixed set point controller or as a single ramp controller. If the ramp rate is set to a value other than "oFF", the process will increase or decrease at the setting rate during initial power up or with set point change. The ramp rate is in degree per min. or sec. depends on the time scaleset in PTME.

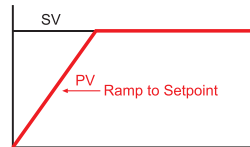

Figure 9. Ramp Function

Soft start time

Soft start time can be programmed in situation where 100% output is not allowed at power up. The time duration for the output to rise from 0% to 100% is defined as soft start time.

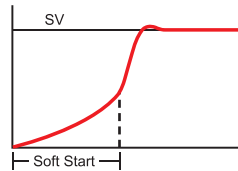

Figure 10. Soft Start

3.3.5. PID Level

Display	Description	Range	Default	Unit
Pb	Proportional band	0.0~300.0	5.0	%
tI	Integral time	oFF, 1~3000	240	Sec.
tD	Derivative time	oFF, 1~1000	60	Sec.
nr	Manual reset	0.0~51.0	0.0	%
AR	Anti-reset windup	0.0~100.0	50.0	%
HYS	Hysteresis for ON/OFF control	0~1000 (0.0~100.0)	0	uint
CL	Cycle time	1~60	15	Sec.

Proportional band

Set the proportional band in percentage of SPAN (High limit - Low limit). It can be set automatically by auto-tuning process.

Integral time

Set the integral time constant in repetitions per second. It can be set automatically by auto-tuning process.

Derivative time

Set the derivative time constant in second. It can be set automatically by auto-tuning process.

Manual reset

For PID control, this value is set automatically after auto-tuning process. For P control, it is used to compensate the deviation between process value and set point.

Anti-reset windup

The anti-reset windup (ARW) inhibits the integral action until the process value is within the band thus reducing overshoot on start-up. The ARW can be set automatically by auto-tuning process and then can be changed manually if required

Hysteresis for ON/OFF control

In ON/OFF control (Proportional band set to 0.0%), the control output turns On/Off with respect to the set point. Therefore, the control output would change frequently in response to a slight change in process value. This might shorten the service life of the output device. To prevent this, a hysteresis is provided in the ON/OFF control.

Cycle time

Set the control output cycle time. It is recommended to set to 15 sec. for Relay output and set to 1 sec. for pulsed voltage output.

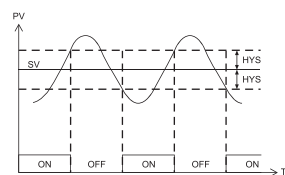

Figure 11. ON/OFF Control Action

3.3.6. Option Level

Display	Description	Range	Default	Unit
TYPE	Input signal type	J : J type K : K type T : T type E : E type b : B type r : R type S : S type n : N type C : C type d-PE : PT100 (DIN) J-PE : PT100 (JIS) mA : mA mV : mV V : V	K type	N/A
SCAL	Low scale for linear input	-1999~9999	0	Unit
SCAH	High scale for linear input	-1999~9999	1000	Unit

CUT	Cut-off function	nonE : None Lo : Low Hi : High HiLo : High/Low	None	N/A
Unit	Unit	oC : °C oF : °F Eng : Engineer	°C	N/A
dP	Decimal point	0000 000.0 00.00 (for linear input signal only) 0.000 (for linear input signal only)	0000	N/A
ACT	Control action	dir : Dir rev : Rev	Rev	N/A
LoL	Low limit	Refer to table 1.	0	Unit
HiL	High limit	Refer to table 1.	1000	Unit
FiL	Digit filter	0.0~99.9	0.0	Sec.
PE	Time scale	HHMM : HH.MM mmSS : MM.SS	HH.MM	N/A
ErOP	Error protection	0000 0001 0010 0011	0000	N/A
LoCK	Security lock	0000 0001 0010 0011 0100 0101 0110	0110	N/A
SoF	Setpoint offset	-1999~9999 (dP =0000) -199.9~999.9 (dP =000.0) -19.99~99.99 (dP =00.00) -1.999~9.999 (dP =0.000)	0	Unit
id	Communication ID	1~247	247	N/A
baUD	Baud rate	24B : 2.4K 48B : 4.8K 96B : 9.6K 192B : 19.2K	19.2K	bps

Input signal type

Select the input signal type. The available input signal types are :

Thermocouple : J K T E B R S N C

RTD : PT100 (JIS standard) or PT100 (DIN standard)

Linear : 0~24mA, -60~60 mV or 0~10 V

Please note that the internal gaps on the main board of MI-4850 controller should be configured in accordance with input signal.

	G1	GA1	GB1	GY
Thermocouple	Linked	Linked	Open	Open
RTD	Open	Linked	Open	Open
0~24 mA	X	Linked	Open	Linked
-60~60 mV	X	Linked	Open	Open
-10~10 V	X	Open	Linked	Open

X : don't care

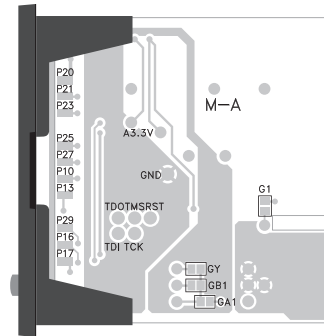

Figure 12. Gaps Allocation

Low scale for linear input

Select the low scale corresponding to low linear input signal. The default low linear input signal (INL) for mA, mV and V is 4.00mA, 0.00mV and 0.00V separately. This parameter is only showed when the input signal type is set to linear. (See also the cut-off function for further detail)

High scale for linear input

Select the high scale corresponding to high linear input signal. The default low linear input signal (INH) for mA, mV and V is 20.00mA, 50.00mV and 10.00V separately. This parameter is only showed when the input signal type is set to linear. (See also the cut-off function for further detail)

Cut-off function

The Cut-off function is used to limit the process value of linear input signal within the boundary whenever the input signal is out of the scale. The cut-off function can be set to "Low", "High" or "High/Low", set to "None" disable the cut-off function. The cut-off function has no effect for input signal other than linear type and is only showed when the input signal type is set to linear.

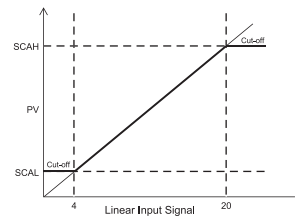

Figure 13. Scale and Cut-off Function

PV scale calculation : $PV = \frac{IN - INL}{INH - INL} (SCAH - SCAL) + SCAL$ where IN is the input signal.

Example : For a 4~20mA input signal, the INL=4.00mA INH=20.00mA. Set SCAL=0.0 and SCAH=100.0 (Of course, you may select other value for Decimal point to alter the resolution). For a 12mA input, the PV will be 50.0 for a 12mA input. For a 22mA input, the PV will be 112.5 with cut-off function set to "None" or 100.0 with cut-off function set to "High" or "High/Low". For a 0mA input, the PV will be -25.0 with cut-off function set to "None" or 0.0 with cut-off function set to "Low" or "High/Low".

Unit

Select the process value indication in °C or °F when the input signal type is set to thermocouple or PT100. Select engineer unit for linear input (mA, mV or V).

Decimal point

Select the decimal point position. The setting 00.00 and 0.000 is available for linear input only.

Control action

Dir – Direct action used for cooling process
Rev – Reverse action used for heating process

Low limit

Set the low limit of measuring range. When the PV goes below the low limit, the PV display flashing indicates a low limit error. The control output and alarm will be set according to the Error Protection.

High limit

Set the high limit of measuring range. When the PV goes beyond the high limit, the PV display flashing indicates a high limit error. The control output and alarm will be set according to the Error Protection.

Digit filter

Set the time constant for digit filter (the first order filter). It is useful when the process value is too unstable to be read.

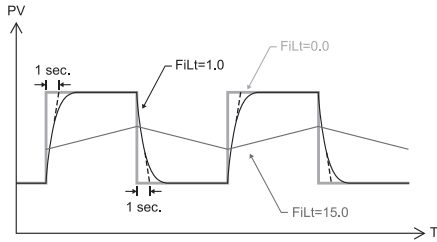

Figure 14. Digit Filter

Time scale

Set the time scale used for alarm delay time and ramp rate.
 HH.MM – The alarm delay time is in hour and minute. The ramp rate is in per minute.
 MM.SS – The alarm delay time is in minute and second. The ramp rate is in per second.

Error protection

Set the control output and alarm status whenever an error occurred. (refer to 4 Error Message)

Error protection	Alarm	Control output
0000	OFF	OFF
0001	OFF	ON
0010	ON	OFF
0011	ON	ON

Security lock

The security lock is useful to lock out the parameters from unauthorized changed

Security lock	Description
0000	Only the security lock is open to change, all other parameters are locked
0001	Only the security lock and set point value is changeable. all the other parameters are locked
0010	The user level is open to change.
0011	The user and alarm levels are open to change.
0100	The user, alarm, and soft levels are open to change.
0101	The user, alarm soft and PID levels are open to change.
0110	All parameters are open to change.

Set point offset

Shift the set point value with an offset. The actual control target is shifted with this offset from set point value but not added to SV display.

Communication ID

Set the ID number in the communication network

Baud rate

Set the communication baud rate.

4.Error Message

Display	Error Description	Correction
oPEr	Sensor break or open	1. Check the sensor is connected and input signal type is selected correctly. 2. Replace the sensor
RdEr	Input signal has out of A/D converter range	1. Check the sensor is connected and input signal type is selected correctly. 2. Replace the sensor. 3. Return to the supplier for repairing
EPEr	The content of EEPROM is corrupt	1. Return to default setting by pressing shift and down keys simultaneously while power on. And reconfigure the parameters 2. Return to the supplier for repairing
ALtEr	Fail to complete the auto-tuning process within 2 hours	1. Retry the auto-tuning again. 2. Improve the control process to have fast response or use manual tuning instead of auto-tuning
Flashing	The PV is out of range	1. Check the sensor is connected and input signal type is selected correctly 2. Check the polarity of sensor is connected correctly 3. Check the high/low limit is set properly. 4. Replace the sensor

8 Hagavish st., P.O.B. 1951 Holon 58117, Israel
 Tel. 972-3-6508585 Fax. 972-3-6508586
 Email: info@michshur.com www.michshur.com



Michshur s.z. (1984) LTD.